

PRODUCT NO. DSIC05LJGET	NO. 1	RoHS compliant
-----------------------------------	-----------------	-----------------------

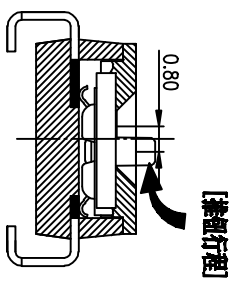

(Construction)

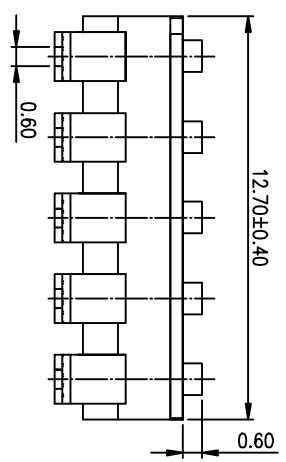
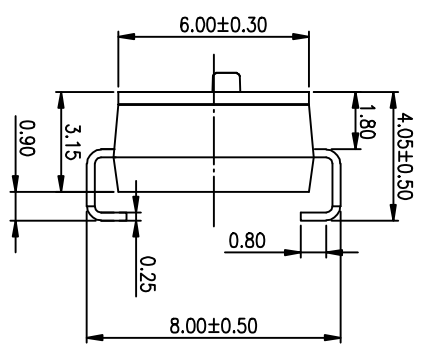
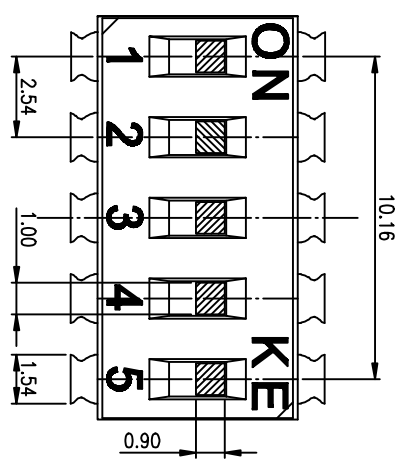
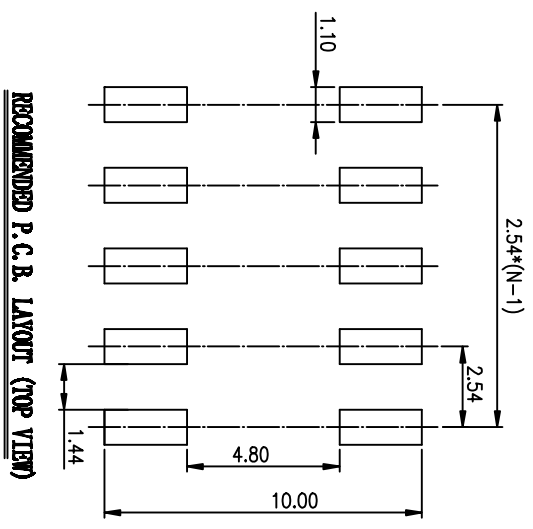
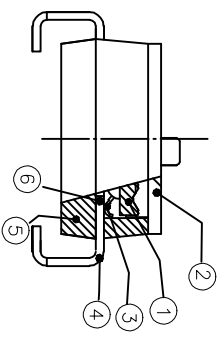

RECOMMENDED P.C.B. LAYOUT (TOP VIEW)

- NOTES :
1. Specification:
- 1>. Operating force: 1000gf Max
 - 2>. Operating Temperature: -40° to +85°
 - 3>. Storage Temperature: -40° to +85°
 - 4>. Mechanical Life: 3000cycles minimum
 - 5>. Electrical Life: 2000cycles 25mA 24VDC
2. PLATING:
- GOLD FLASH 1u"(min.) SOLDER TAIL,
 - 3u" GOLD PLATING ON THE CONTACT AREA,
 - WITH 50u" NICKEL UNDERPLATING OVERALL.

3. PART NUMBER DESCRIPTION

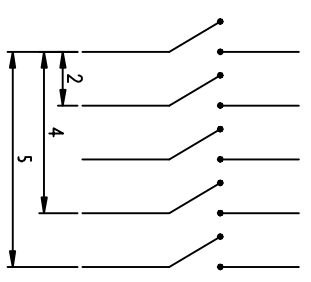
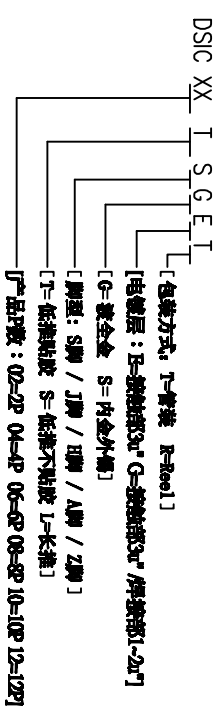

[Schematic]

Number	Part Name	Material	Finished
①	Actuator	UL94 V0	White
②	Cover	UL94 V0	Black
③	Movable	Copper Alloy	3u"Gold
④	Terminal	Brass	1u"Gold
⑤	Base	UL94 V0	Black
⑥	Terminal Contact	Brass	3u"Gold

TOLERANCE UNLESS OTHERWISE SPECIFIED		INSPECTION COPY	
LINER	ANGLES	PROJECTION	COPY
0 ± 0.25	0 ± 2'		
.00 ± 0.15	.0 ± 1'		
.000 ± 0.10	.00 ± 0.5'		
DESIGN	kathy	2012/04/12	
DRAWING			
CHECK			
APPRO.			

Kingtek 德普特电子股份有限公司
Dongguan Kingtek Industrial Co., Ltd.

FILE NO.	DSIC05LJGET-A
SIZE	UNIT SCALE SHEET REV.
A4	mm 2 : 1 10F 1 A